



三相进线电抗器 Line Reactor

HKSG2-0.8 Series

- ♥限制交流换相时电网侧的压降
- ♥减少电网的低次谐波污染，提高功率因数
- ♥限制晶闸管导通时电流上升率 di/dt 和电压上升率 du/dt
- ♥Limiting voltage drop in grid side, during phase commutation
- ♥Reducing harmonic pollution, improving the power factor
- ♥Limiting the current and voltage increasing rate(di/dt & du/dt).

技术参数

- ♥额定电压：3AC 220~1140V
- ♥电流：2~6000A
- ♥频率：50~120Hz
- ♥耐压测试：3~5Kv
- ♥绝缘等级：F、H
- ♥海拔高度：≤3000m
- ♥环境温度：-25 ~ +40°C
- ♥电抗率：1~8%
- ♥防护等级：IP00

Technical Specifications

- ♥Rated voltage: 3AC 220~1140V
- ♥Current: 2~6000A
- ♥Frequency: 50~120Hz
- ♥High voltage test: 3~5Kv
- ♥Insulation class: F、H
- ♥Altitude: ≤3000m
- ♥Ambient temperature: -25 ~ +40°C
- ♥Impedance rate: 1~8%
- ♥Protection: IP00

应用示意图

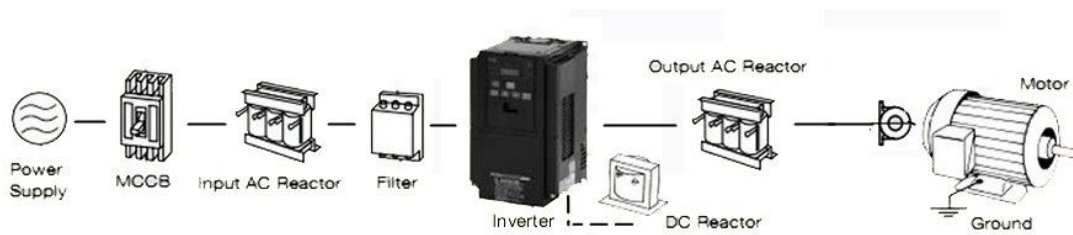



三相输出电抗器 Output Reactor

CKSG1/2 -0.8 Series

- ♥ 补偿长线分布电容充电电流
- ♥ 有效降低 IGBT 输出的高 du/dt,
- ♥ 减小电机的噪音
- ♥ Compensating capacitive charging current in the long line
- ♥ Decreasing high du/dt outputed by IGBT
- ♥ Reducing motor noise

技术参数

- ♥ 额定电压：3AC 220~1140V
- ♥ 电流：2~6000A
- ♥ 频率：50~120Hz
- ♥ 耐压测试：3~5Kv
- ♥ 绝缘等级：F、H
- ♥ 海拔高度：≤3000m
- ♥ 环境温度：-25 ~ +40°C
- ♥ 电抗率：1~8%
- ♥ 防护等级：IP00

Technical Specifications

- ♥ Rated voltage: 3AC 220~1140V
- ♥ Current: 2~6000A
- ♥ Frequency: 50~120Hz
- ♥ High voltage test: 3~5Kv
- ♥ Insulation class: F、H
- ♥ Altitude: ≤3000m
- ♥ Ambient temperature: -25 ~ +40°C
- ♥ Impedance rate: 1~8%
- ♥ Protection: IP00

应用示意图

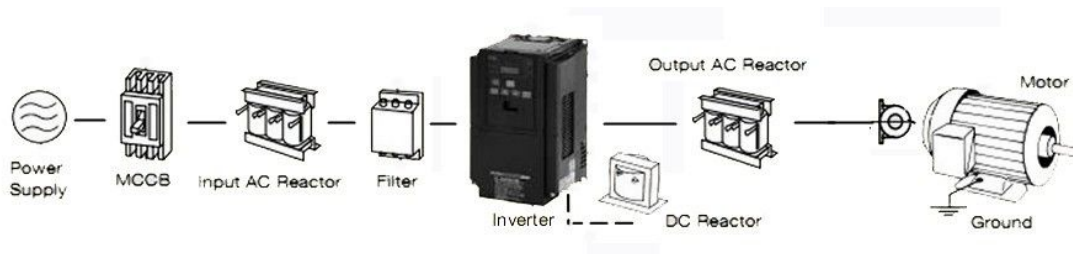



直流平波电抗器 DC Smoothing Reactor

PKG1/2/3-0.8/1.2 Series

- ♥ 限制叠加在直流上的交流分量，保持整流电流连续
- ♥ 减小直流母线交流脉冲，有效提高功率因数
- ♥ 抑制交流装置产生的谐波
- ♥ Limiting AC component to be overlaid on DC current, to keep continuous rectified current
- ♥ Reducing AC pulse in DC bus, effectively improve the power factor
- ♥ Suppressing harmonics

型号说明(Model)

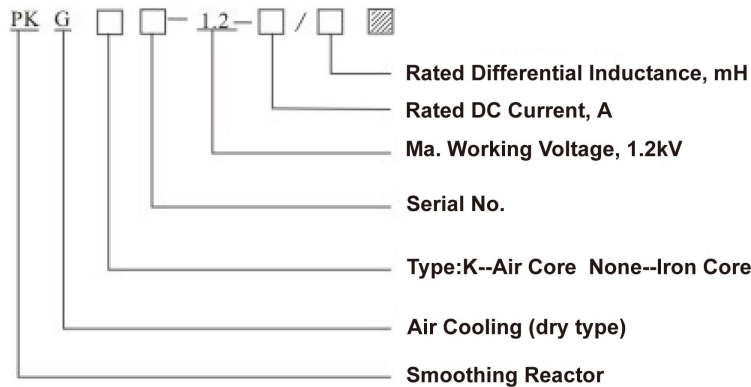

技术参数

- ♥ 额定电压：DC 220~1140V
- ♥ 电流：2~6000A
- ♥ 耐压测试：3~5Kv
- ♥ 绝缘等级：F、H
- ♥ 海拔高度：≤3000m
- ♥ 环境温度：-25 ~ +40℃
- ♥ 电抗率：1~8%
- ♥ 防护等级：IP00

Technical Specifications

- ♥ Rated voltage: DC220~1140V
- ♥ Current: 2~6000A
- ♥ High voltage test: 3~5Kv
- ♥ Insulation class: F、H
- ♥ Altitude: ≤3000m
- ♥ Ambient temperature: -25 ~ +40℃
- ♥ Impedance rate: 1~8%
- ♥ Protection: IP00

应用示意图

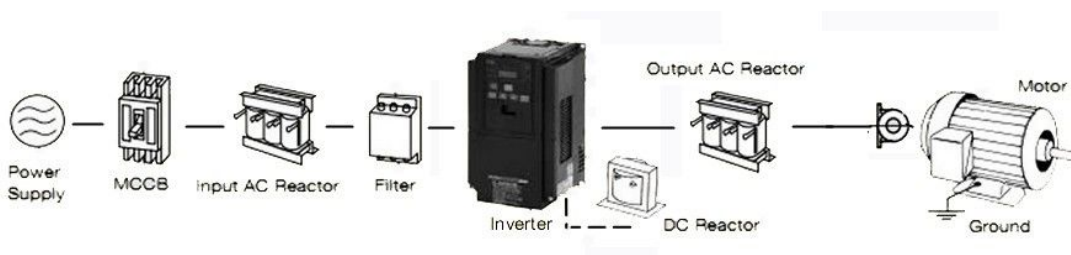



限流电抗器 Current Limiting Reactor

XKSG 1-0.8 Series

- ♥与电容器串联
- ♥限制合闸涌流和电流上升率 (di/dt)
- ♥ Series with capacitor
- ♥Limiting switching inrush current and current increasing rete (di/dt)

型号说明(Model):

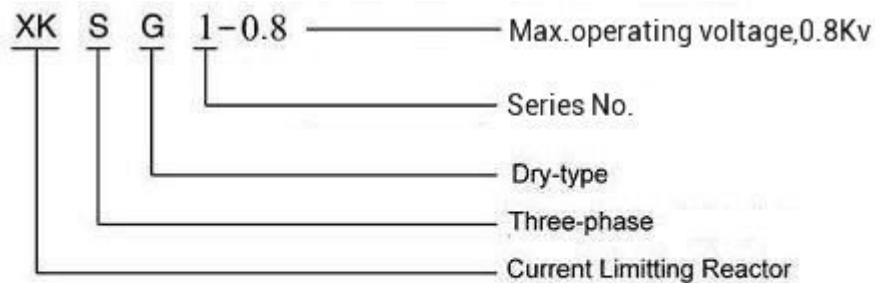

技术参数

- ♥相数: 单相/三相
- ♥额定电压: 220-1140V
- ♥电抗率: 1~8%
- ♥耐压测试: 3~5kV
- ♥绝缘等级: F、H
- ♥冷却方式: 自冷
- ♥海拔高度: ≤3000m
- ♥环境温度: -25 ~ +40°C
- ♥防护等级: IP00

Technical Specifications

- ♥Phase: Single/ three
- ♥Rated voltage: 220-1140V
- ♥Impedance rate: 1~8%
- ♥High voltage test: 3~5kV
- ♥Insulation class: F、H
- ♥Cooling type: AN
- ♥Altitude: ≤3000m
- ♥Ambient temperature: -25 ~ +40°C
- ♥Protection: IP00

基本订货参数(Basic order parameters):

1. 额定容量(Rated power) 2. 额定电压(Rated Voltage) 3. 额定电抗率(Rated reactance rate)
4. 额定电流或最大连续电流(Rated current or Max. Continuous current)



低压串联电抗器 LV Series Reactor

CLKSG1-0.8 Series

- ♥与电容器串联 Series with capacitor
- ♥抑制高次谐波 Suppressing harmonics
- ♥限制涌流 Limiting inrush current
- ♥滤除谐波 Filtering harmonics
- ♥提高功率因数 Improving power factor

型号说明(Model):

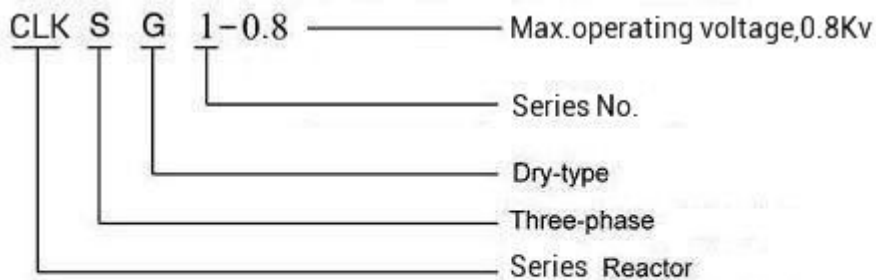

技术参数

- ♥额定电压: 220-1140V
- ♥电抗率: 1~14%
- ♥耐压测试: 3~5Kv
- ♥绝缘等级: F、H
- ♥冷却方式: 自冷
- ♥海拔高度: ≤3000m
- ♥环境温度: -25 ~ +40℃
- ♥防护等级: IP00

Technical Specifications

- ♥Rated voltage: 220-1140V
- ♥Impedance rate: 1~14%
- ♥High voltage test: 3~5Kv
- ♥Insulation class: F、H
- ♥Cooling type: AN
- ♥Altitude: ≤3000m
- ♥Ambient temperature: -25 ~ +40℃
- ♥Protection: IP00

基本订货参数 (Basic order parameters):

1. 额定容量 (Rated power)
2. 额定电压 (Rated voltage)
3. 额定电抗率 (Impedance rate)
4. 配套电容器组的额定电压 (Rated voltage of capacitor bank)
5. 额定电流或最大连续电流 (Rated current or Max. Continuous current)



铁芯串联电抗器 Iron Core Series Reactor

CKSC Series

- ♥与电容器串联 Series with capacitor
- ♥抑制高次谐波 Suppressing harmonics
- ♥限制涌流 Limiting inrush current
- ♥滤除谐波 Filtering harmonics
- ♥提高功率因数 Improving power factor

型号说明(Model):

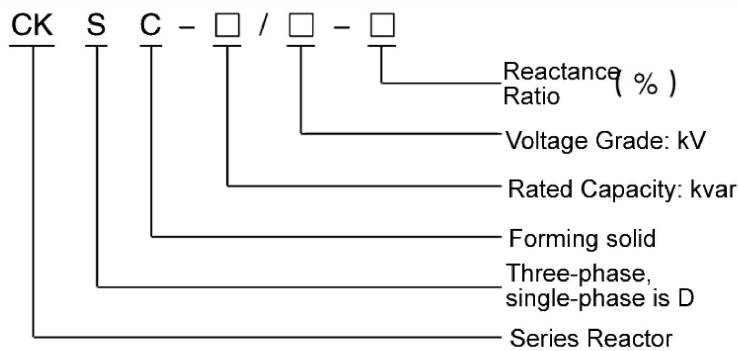

技术参数

- ♥额定电压: 3~10Kv
- ♥电抗率: 1~14%
- ♥绝缘等级: F、H
- ♥海拔高度: ≤3000m
- ♥环境温度: -25 ~ +40°C
- ♥防护等级: IP00

Technical Specifications

- ♥Rated voltage: 3~10Kv
- ♥Impedance rate: 1~14%
- ♥Insulation class: F、H
- ♥Altitude: ≤3000m
- ♥Ambient temperature: -25 ~ +40°C
- ♥Protection: IP00

基本订货参数(Basic order parameters):

1. 额定容量(Rated power)
2. 额定电压(Rated voltage)
3. 额定电抗率(Rate impedance rate)
4. 配套电容器组的额定电压(Rated voltage of capacitor bank)
5. 冷却方式 (Cooling type AN/AF)
6. 额定电流或最大连续电流(Rated current or Max. Continuous current)



华盛隆电气有限公司
HSL ELECTRICAL EQUIPMENT CO., LTD.

HSL EC
Huo Sheng Long Electrical Equipment



☎ : 86 (0) 335 856 0000
☎ : 86 (0) 335 851 5333

🏠 : No.3, Helanshan Road, Economy & Technology Development Zone, Qinhuangdao, Hebei, China



